

PLANTA BAIXA RECEPÇÃO

ESC.: 1/20

PREFEITURA MUNICIPAL DE ATALANTA

PROJETISTA:
 ENG. CIVIL TAINÁ KRAMEL
 DATA:
 05/03/2024

LOCAL:
 ATALANTA - SC

PROJETO:
 RECEPÇÃO
 REFERÊNCIA:
 PLANTA BAIXA

PRANCHA:
01/04



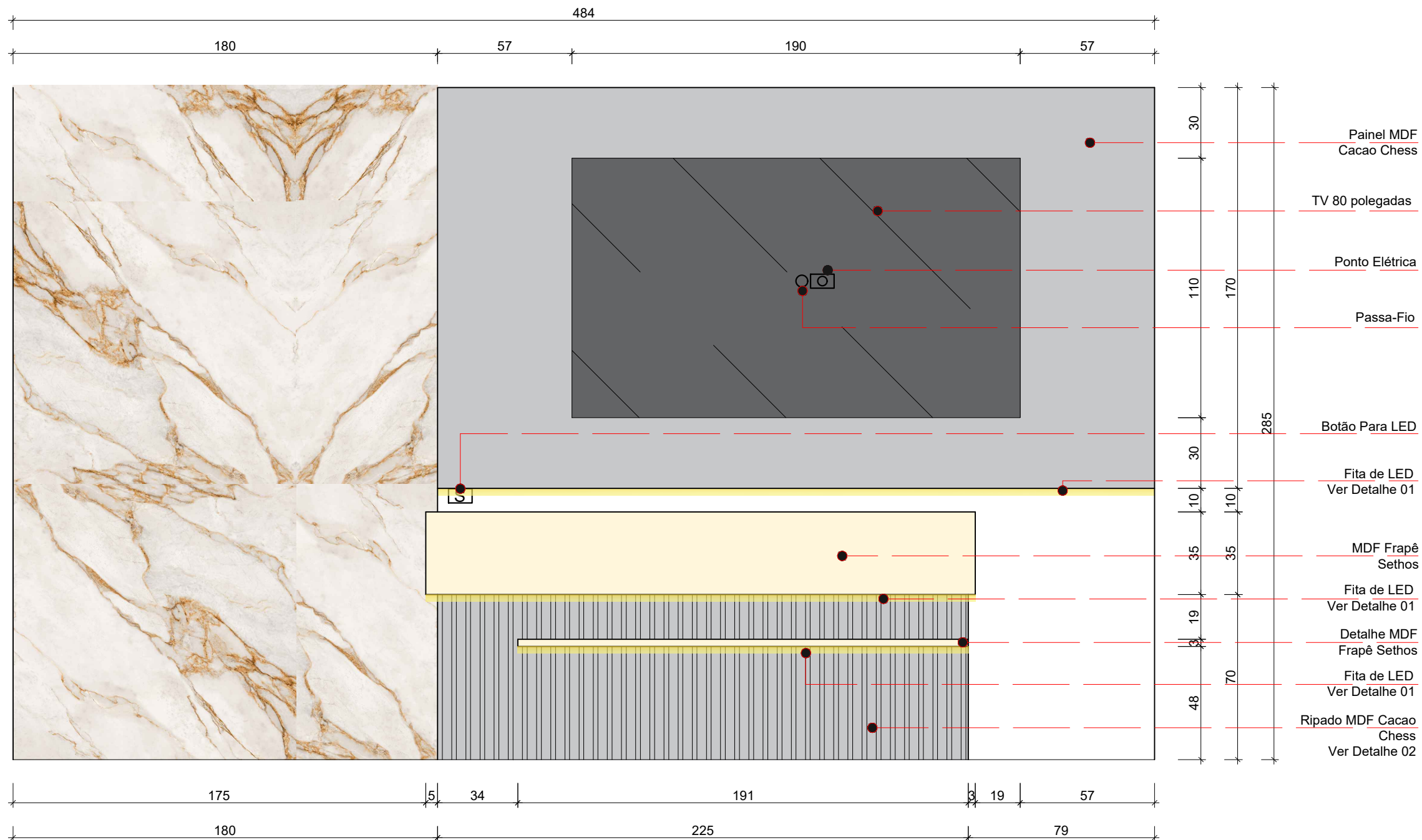

VISTA FRONTAL RECEPÇÃO

ESC.: 1/20

LEGENDA DE MDF

- MDF CACAO CHESSE
- MDF FRAPÊ CHESSE
- MDF BRANCO TX
- MDF EM CORTE

LEGENDA PONTOS ELÉTRICOS

- PONTO DE TOMADA A ACRESCENTAR
- PONTO DE TV
- PONTO DE INTERRUPTOR
- PASSA-FIO

PREFEITURA MUNICIPAL DE ATALANTA

PROJETISTA:
ENG. CIVIL TAINÁ KRAMEL
DATA:
05/03/2024

LOCAL:
ATALANTA - SC

PROJETO:
RECEPÇÃO
REFERÊNCIA:
VISTA FRONTAL

PRANCHA:
02/04



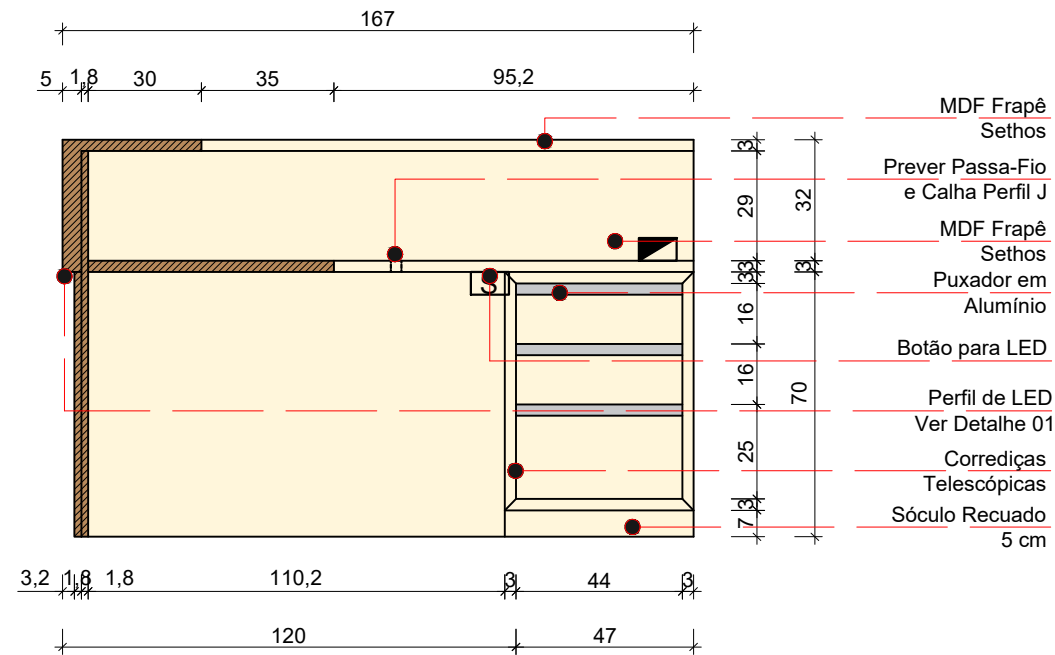

VISTA 01

ESC.: 1/20

OBS.: Gaveteiro na largura do móvel (50 cm) e acabamento interno com MDF Branco TX, prever Passa-fio com Calha Perfil J.

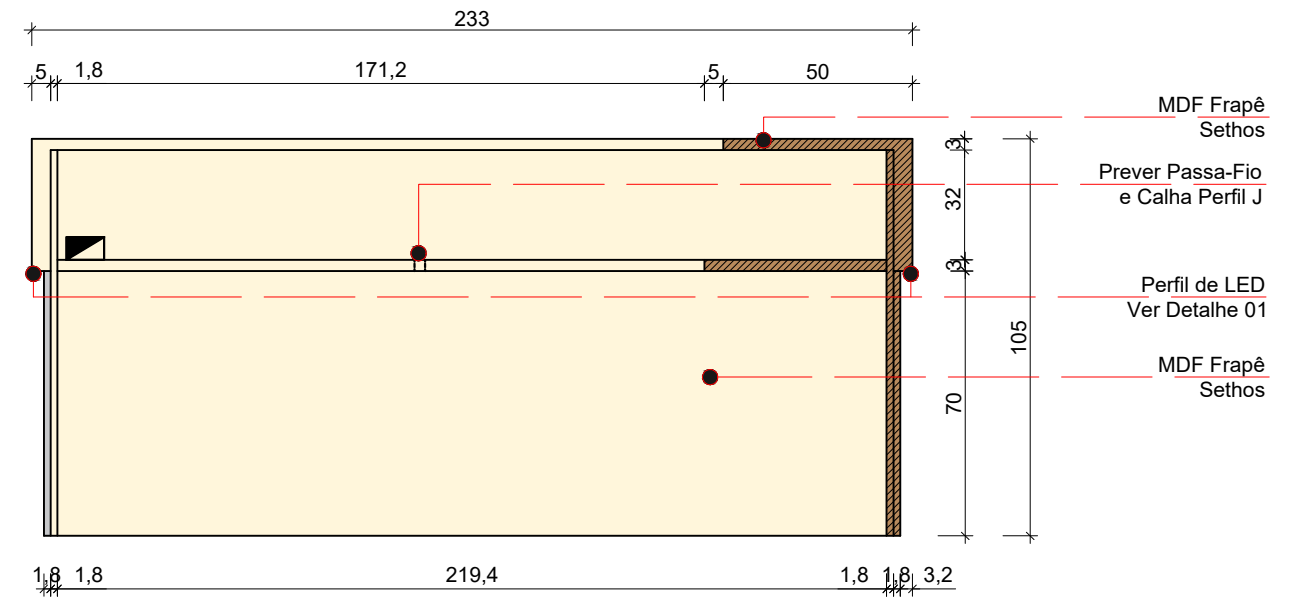

VISTA 02

ESC.: 1/20

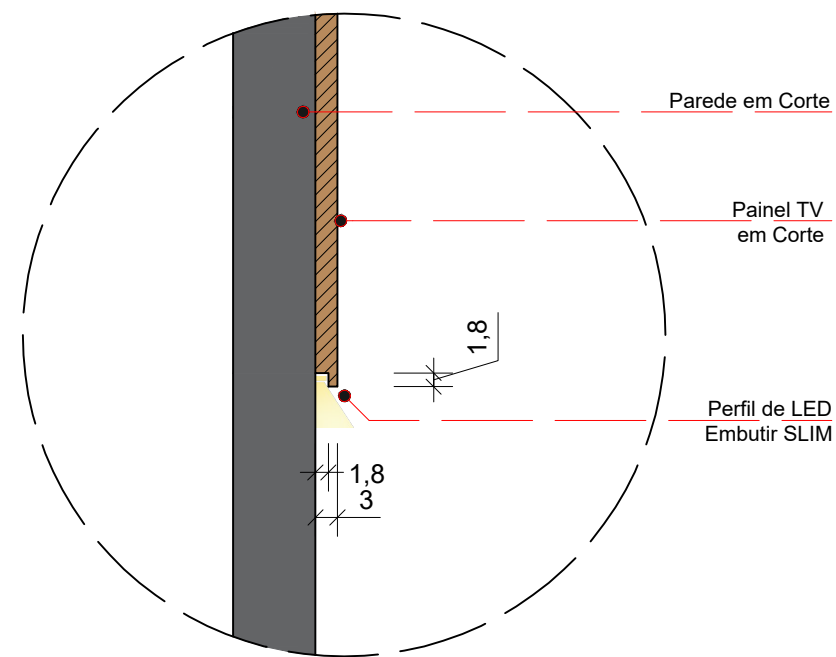

DETALHE 01 - FITA DE LED PAINEL TV

ESC.: 1:10

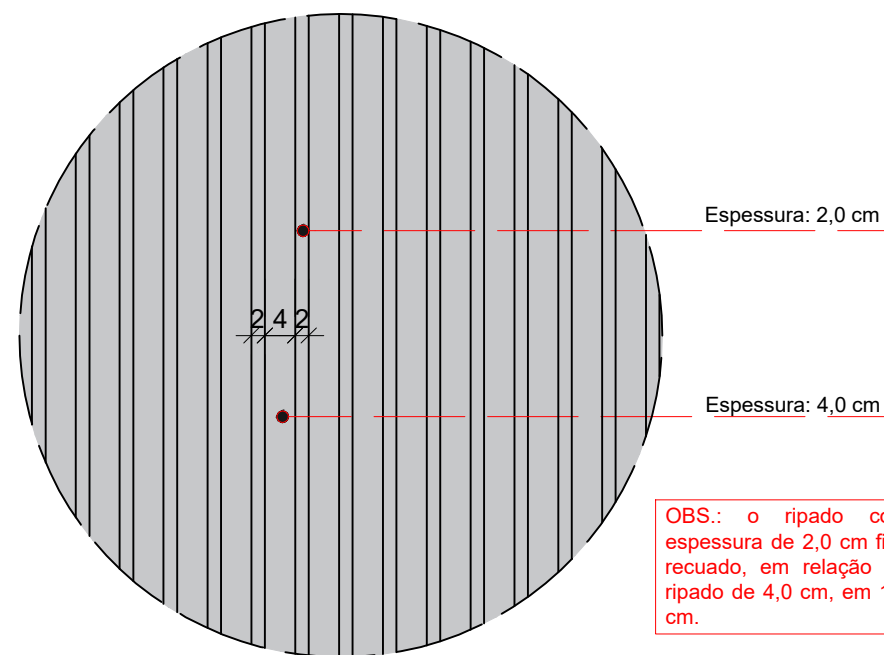

DETALHE 02 - RIPADO

ESC.: 1/10

OBS.: o ripado com espessura de 2,0 cm fica recuado, em relação ao ripado de 4,0 cm, em 1,8 cm.

LEGENDA DE MDF

- MDF CACAO CHESS
- MDF FRAPÊ CHESS
- MDF BRANCO TX
- MDF EM CORTE

LEGENDA PONTOS ELÉTRICOS

- PONTO DE TOMADA Á ACRESCENTAR
- PONTO DE TV
- PONTO DE INTERRUPTOR
- PASSA-FIO

PREFEITURA MUNICIPAL DE ATALANTA

PROJETISTA:
ENG. CIVIL TAINÁ KRAMEL
DATA:
05/03/2024

LOCAL:
ATALANTA - SC

PROJETO:
RECEPÇÃO
REFERÊNCIA:
VISTA 01, VISTA 02, DETALHE 01
E DETALHE 02

PRANCHA:
03/04



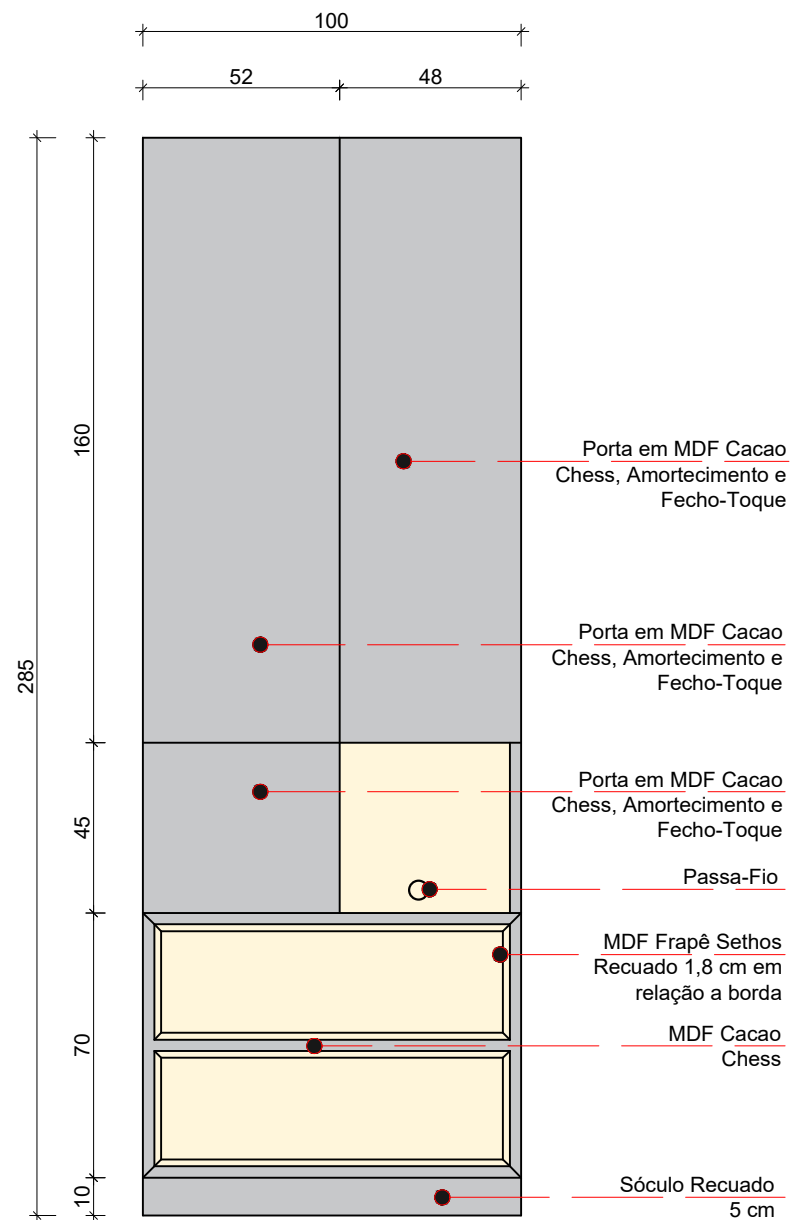





VISTA 03





ESC.: 1/20

OBS.: Largura do móvel (45 cm), porta com Amortecimento e Fecho-Toque.

LEGENDA DE MDF

-  MDF CACAO CHESS
-  MDF FRAPÊ CHESS
-  MDF BRANCO TX
-  MDF EM CORTE

LEGENDA PONTOS ELÉTRICOS

-  PONTO DE TOMADA Á ACRESCENTAR
-  PONTO DE TV
-  PONTO DE INTERRUPTOR
-  PASSA-FIO

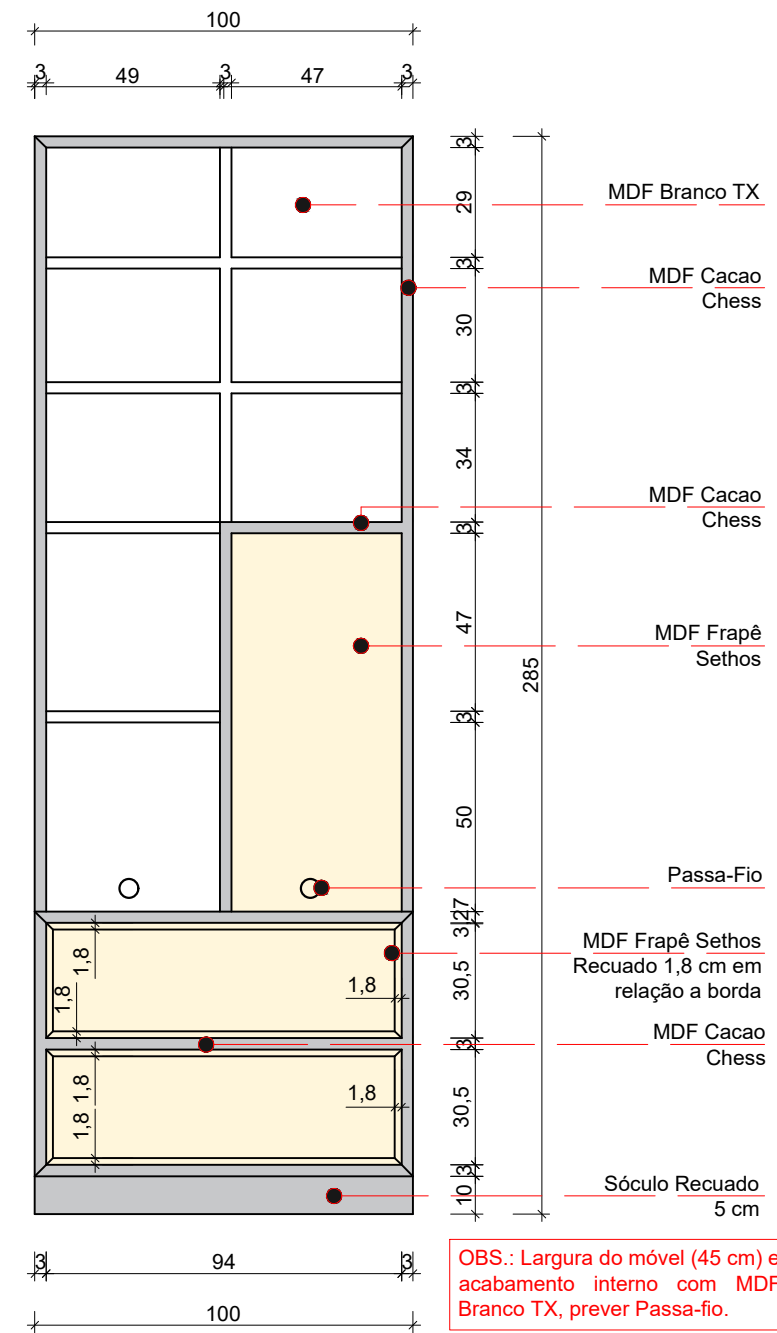

VISTA 03 - INTERNO

ESC.: 1/20

OBS.: Largura do móvel (45 cm) e acabamento interno com MDF Branco TX, prever Passa-fio.

PREFEITURA MUNICIPAL DE ATALANTA

PROJETISTA:
ENG. CIVIL TAINÁ KRAMEL
DATA:
05/03/2024

LOCAL:
ATALANTA - SC

PROJETO:
RECEPÇÃO
REFERÊNCIA:
VISTA 03 E VISTA 03 INTERNO

PRANCHA:
04/04



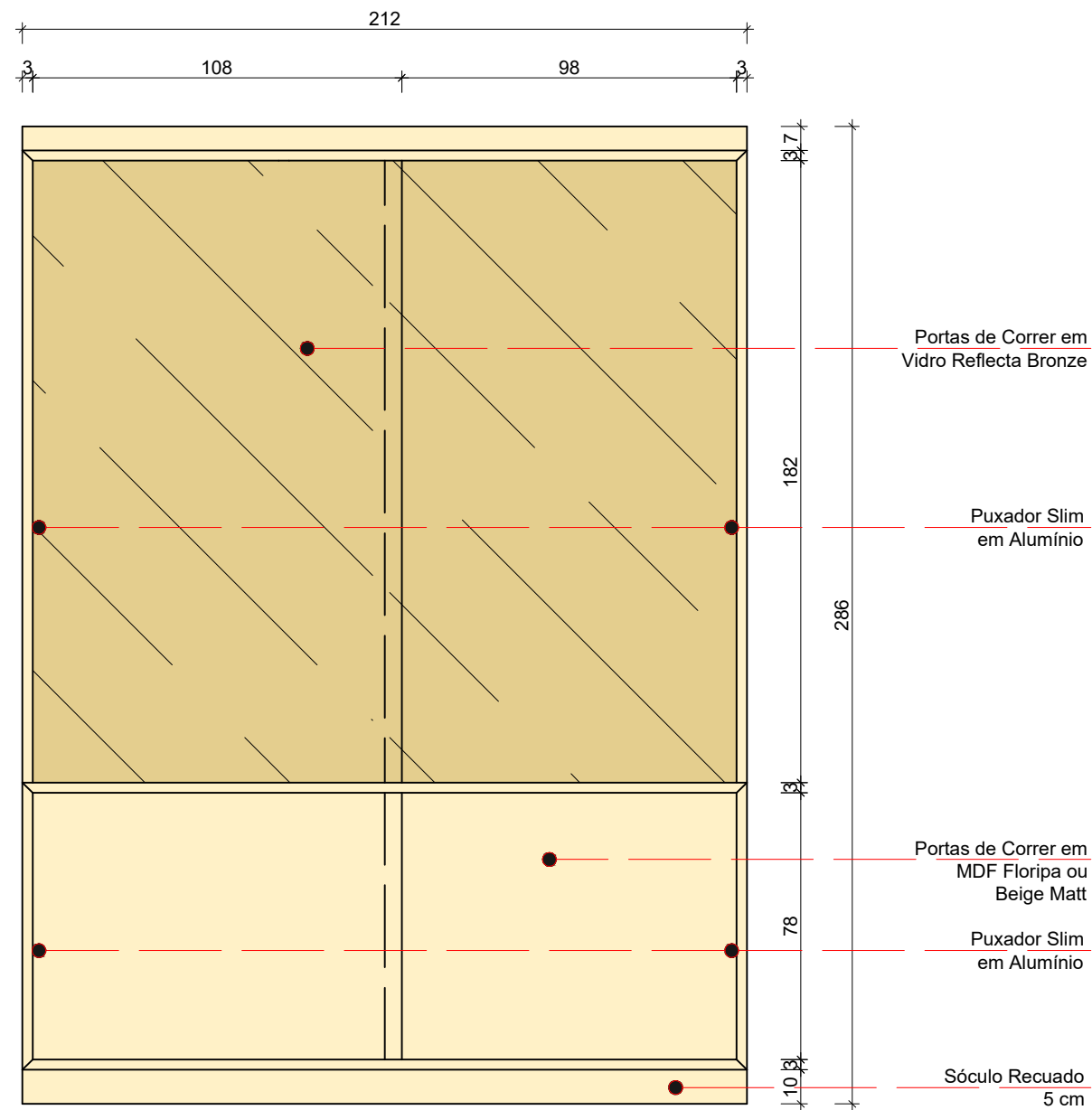

VISTA FRONTAL SEM PORTAS
ESC.: 1/20

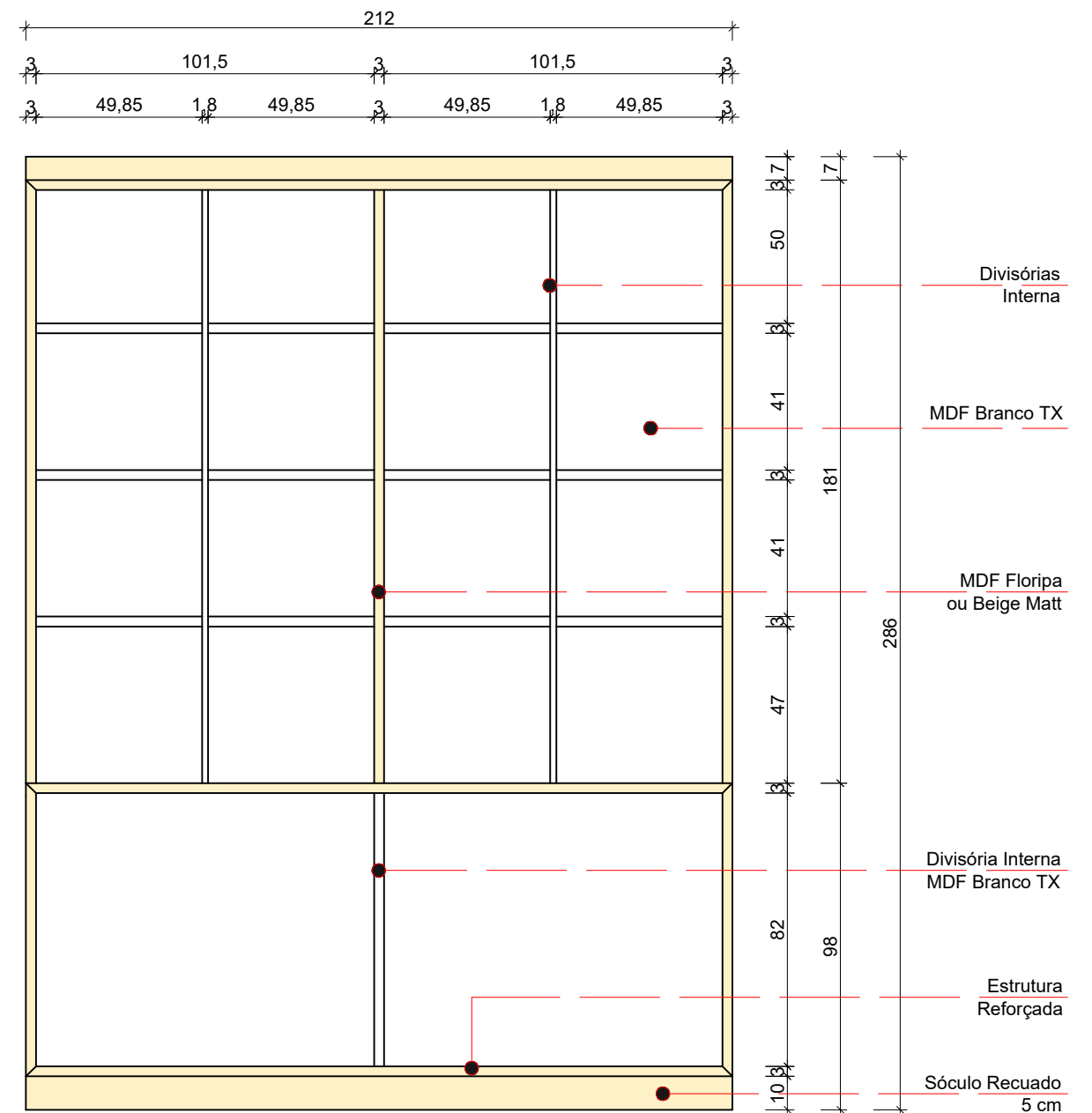

OBS.: Acabamento interno com MDF Branco TX. A estrutura inferior deverá ser reforçada para suportar 150 kg no total.



VISTA FRONTAL COM PORTAS
ESC.: 1/20

OBS.: Acabamento interno com MDF Branco TX. A estrutura inferior deverá ser reforçada para suportar 150 kg no total.

LEGENDA DE MDF

-  MDF FLORIPA OU BEIGE MATT
-  MDF BRANCO TX
-  VIDRO REFLECTA BRONZE

PREFEITURA MUNICIPAL DE ATALANTA

PROJETISTA:
ENG. CIVIL TAINÁ KRAMEL
DATA:
22/03/2024

LOCAL:
ATALANTA - SC

PROJETO:
ARMÁRIO CONTROLE INTERNO
REFERÊNCIA:
PLANTA BAIXA

PRANCHA:
01/02



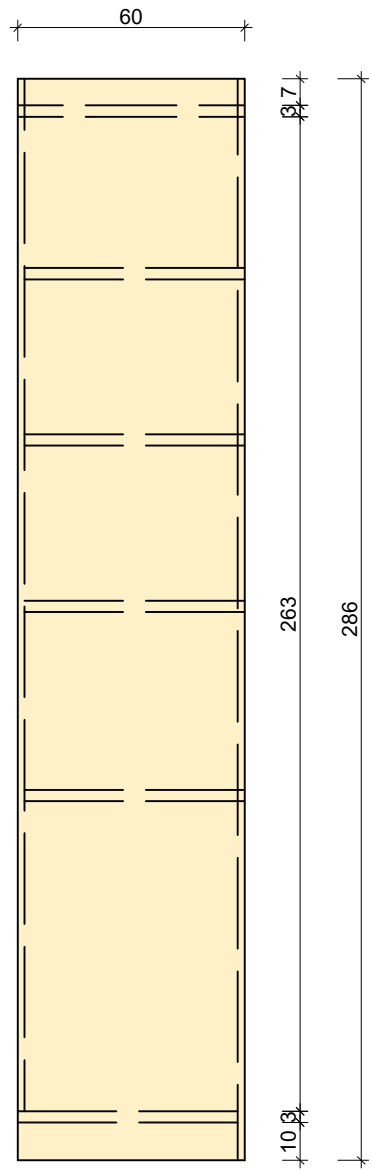

VISTA LATERAL

ESC.: 1/20

LEGENDA DE MDF

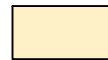

MDF FLORIPA OU BEIGE MATT



MDF BRANCO TX

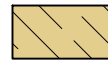

VIDRO REFLECTA BRONZE

PREFEITURA MUNICIPAL DE ATALANTA

PROJETISTA:
ENG. CIVIL TAINÁ KRAMEL

DATA:
22/03/2024

LOCAL:
ATALANTA - SC

PROJETO:
ARMÁRIO CONTROLE INTERNO

REFERÊNCIA:
PLANTA BAIXA

PRANCHA:

02/02

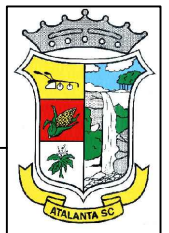

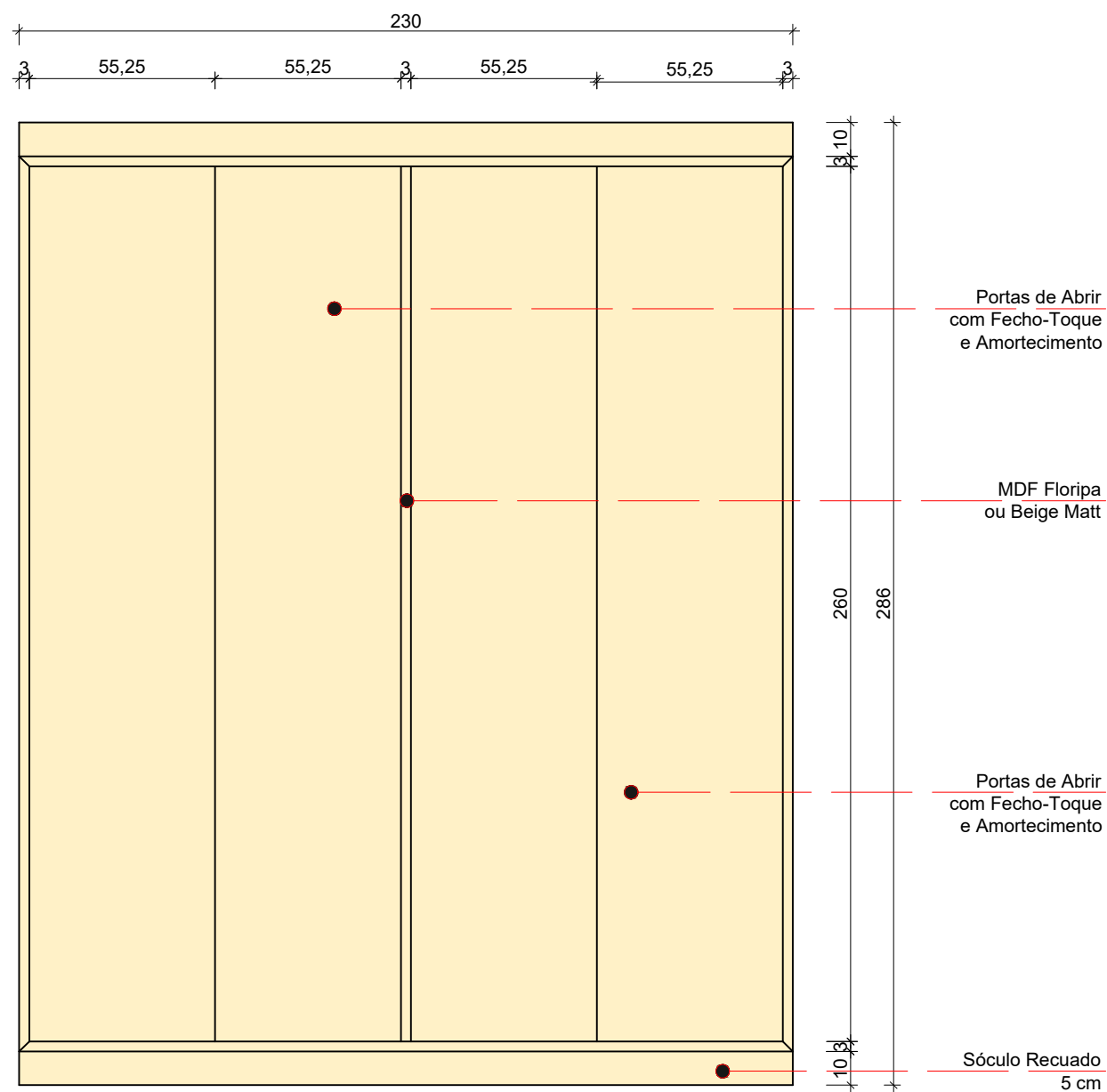

VISTA FRONTAL COM PORTAS
ESC.: 1/20

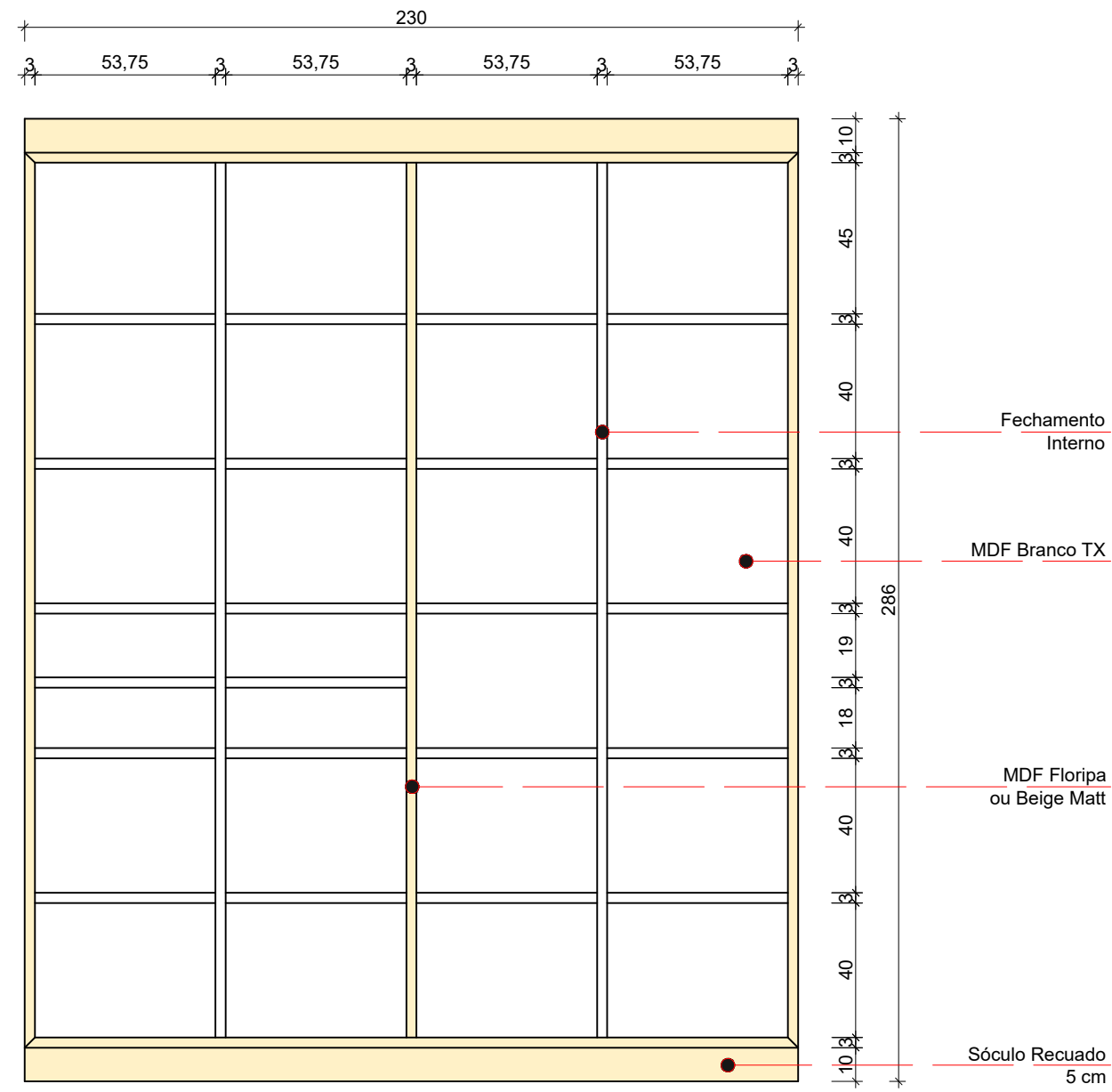

VISTA FRONTAL SEM PORTAS
ESC.: 1/20

OBS.: Acabamento interno com MDF Branco TX, porta com Fecho-Toque e Amortecimento.

LEGENDA DE MDF

- MDF FLORIPA OU BEIGE MATT
- MDF BRANCO TX

PREFEITURA MUNICIPAL DE ATALANTA

PROJETISTA:
ENG. CIVIL TAINÁ KRAMEL
DATA:
20/03/2024

LOCAL:
ATALANTA - SC

PROJETO:
ARMÁRIO FINANCEIRO
REFERÊNCIA:
PLANTA BAIXA

PRANCHA:
01/02



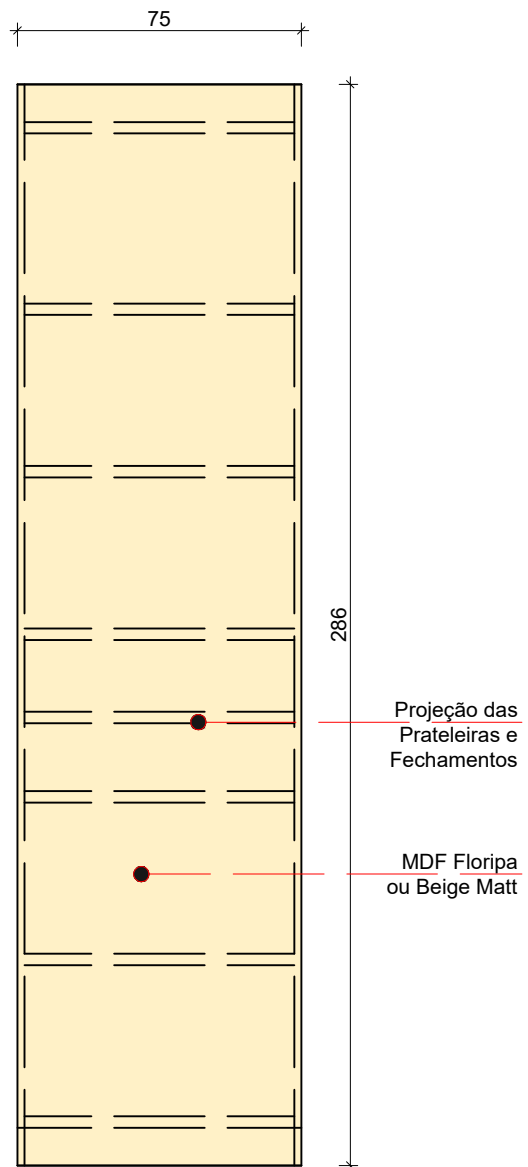

LEGENDA DE MDF

- MDF FLORIPA OU BEIGE MATT
- MDF BRANCO TX

VISTA LATERAL
ESC.: 1/20

PREFEITURA MUNICIPAL DE ATALANTA

PROJETISTA:
ENG. CIVIL TAINÁ KRAMEL

DATA:
20/03/2024

LOCAL:
ATALANTA - SC

PROJETO:
ARMÁRIO FINANCEIRO

REFERÊNCIA:
PLANTA BAIXA

PRANCHA:
02/02

